

GSSTM
SYSTEM

 **eubiq**TM

SH1 & DMS1

POWER AND CABLE
MANAGEMENT TRACK



EXPERIENCE THE ART OF CABLE MANAGEMENT

SH1 & DMS1

PREMIUM CABLE MANAGEMENT SYSTEM

Designed for use with the Modular SFC3 GSS System Power Track, the DMS1 and SH1 series are engineered to exceed the highest standards of modern cable management requirements. DMS1 and SH1 series are easy and quick to install. Snap-on Corner Joints and Multimedia Connectors makes DMS1 and SH1 series the most sophisticated system in the world.

DMS1 APPLICATIONS

Galleries	Retail Outlets
Banks	Showrooms
Libraries	Classrooms
Hotels	
Lounges	

SH1 APPLICATIONS

System Furniture	Test Laboratories
Workstations	Assembly Plants
Home Offices	Workshops
Kitchen	
Pantry	

AWARDS

PRESIDENT'S
DESIGN AWARD
DESIGN OF THE YEAR 2008

IDA
INTERNATIONAL DESIGN
EXCELLENCE AWARDS '08



Flexible

Premium Finishing

Modular Concept

Innovative

Durable

DMS1 POWER AND CABLE MANAGEMENT TRACK

FEATURES

- Skirting mount or dado mid-height mounting
- Dual compartments
- EMI shielded
- Precise alignment of trunking runs with corner links
- Snap-on multimedia connectors
- Durable and Premium finishing
- Uninterrupted Power Supply - (UPS) ready

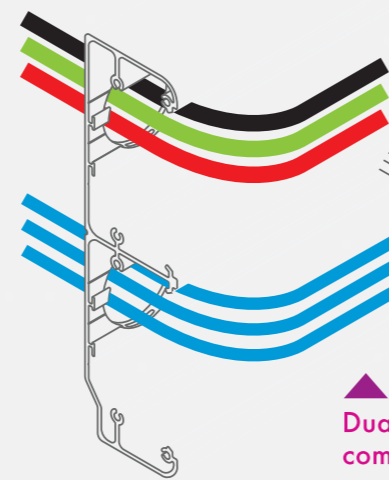

Dual compartments

Precise alignment of trunking runs with corner links

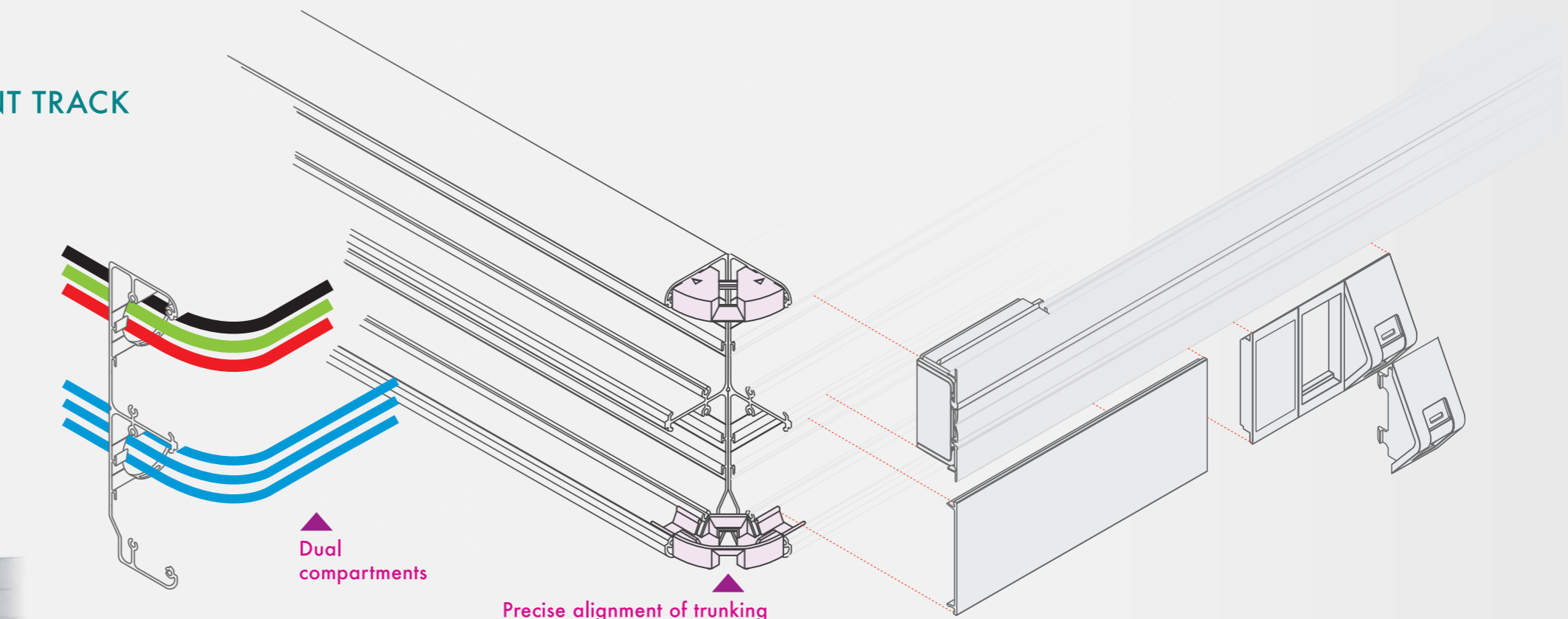

SH1 POWER AND CABLE MANAGEMENT TRACK

FEATURES

- Dado mid-height mounting
- Snap-on multimedia connectors
- Precise alignment of trunking runs with corner links
- Built-in accessory rail
- EMI shielded
- Durable and Premium finishing
- Uninterrupted Power Supply - (UPS) ready



Accessory rail & hooks

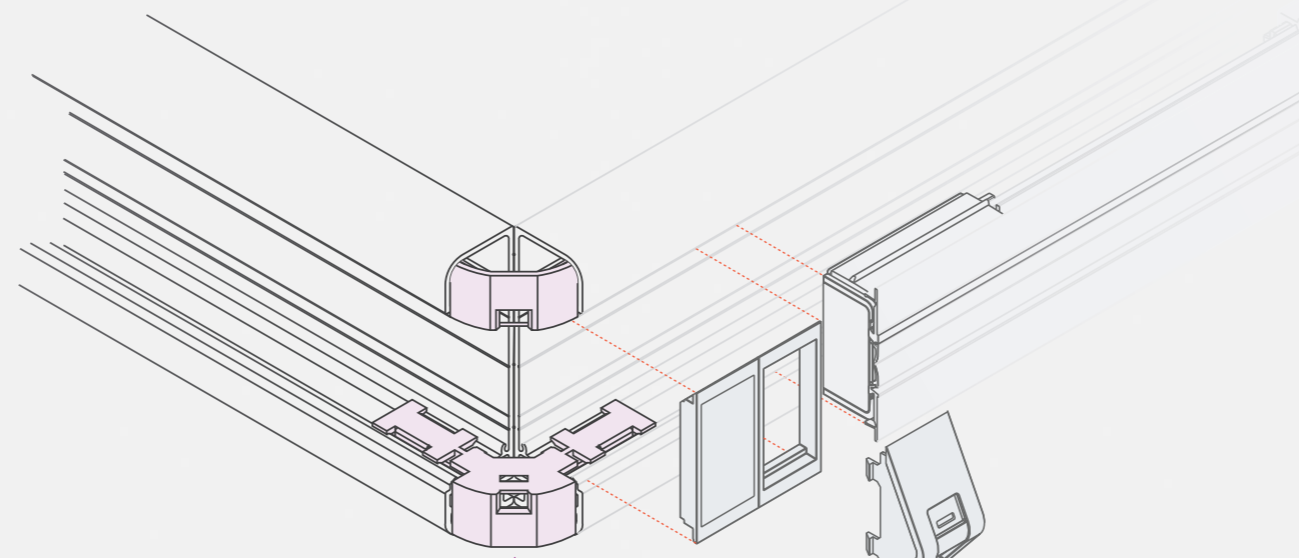

Precise alignment of trunking runs with corner links

DMS1

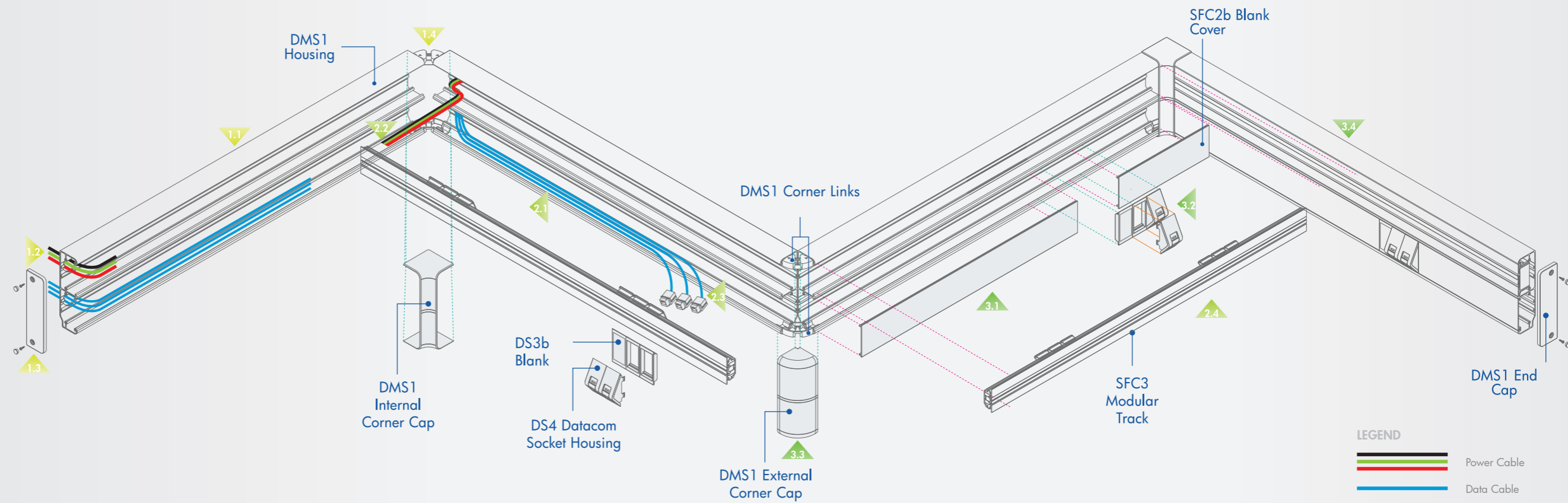

INSTALLATION SEQUENCE



- 1.1 Mount housing.
- 1.2 Layout power and data cables.
- 1.3 Secure End Caps.
- 1.4 Secure Corner Links.

STEP 1

- 2.1 Secure back plate to housing.
- 2.2 Terminate power supply to SFC3 Track.
- 2.3 Terminate data cables to keystone jack.
- 2.4 Snap on SFC3 Track to back plate.

STEP 2

- 3.1 Secure Dummy Covers.
- 3.2 Secure DS3/DS4 Datacom Socket to housing.
- 3.3 Secure internal/external corner caps.
- 3.4 Installation completed.

STEP 3

SH1

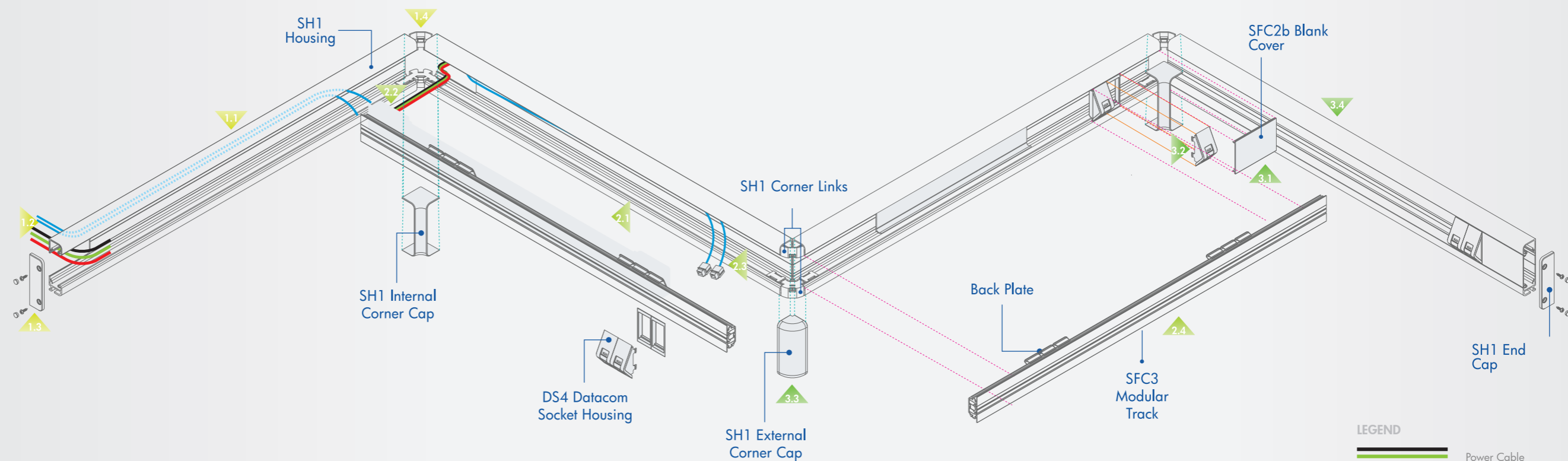

SH1

SPECIFICATIONS

Model Number : SH1

PRODUCT FEATURES

Standard Finishing : **NSB** Natural Shot Blast
NLB Natural Light Blast
 Customised Length : Maximum length is 3300mm
 Please contact local Agent/Distributor for more information

Special Finishings : **BHL** Black Hair Line
 Customised Length : Maximum length is 3300mm
 Please contact local Agent/Distributor for more information

ELECTRICAL

Rated Voltage : 250V a.c. Single-phase
 Rated Current : 40Amp maximum
 Frequency : 50Hz / 60Hz

MATERIAL

Basic Housing Profile : Aluminium
 Track Insulation : Polycarbonate

SIZE AND WEIGHT

Overall Dimension : 100mm x 28.5mm x 1000mm
 (Width x Depth x Length)
 Weight : Estimated 2.2 kg
 Warranty : 3 years subject to Eubiq Limited Statement (Applicable to track only)

Also available in retail package of 600mm, 800mm & 1000mm.
 Please contact your Local Agents/Distributor for more information.

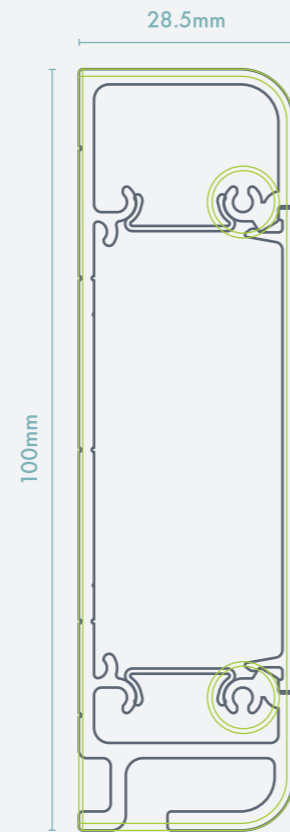

ACTUAL SIZE

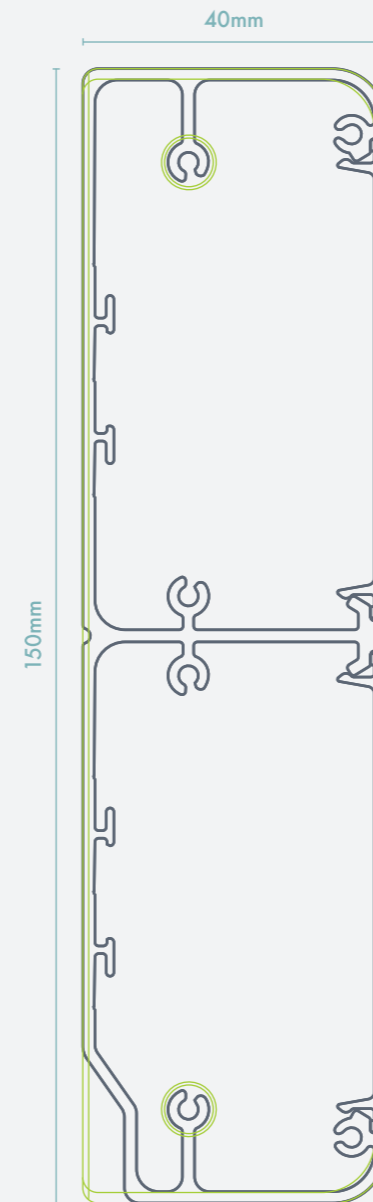

ACTUAL SIZE

DMS1

SPECIFICATIONS

Model Number : DMS1

PRODUCT FEATURES

Standard Finishing : **NSB** Natural Shot Blast
NLB Natural Light Blast
 Customised Length : Maximum length is 3300mm
 Please contact local Agent/Distributor for more information

Special Finishings : **BHL** Black Hair Line
 Customised Length : Maximum length is 3300mm
 Please contact local Agent/Distributor for more information

ELECTRICAL

Rated Voltage : 250V a.c. Single-phase
 Rated Current : 40Amp maximum
 Frequency : 50Hz / 60Hz

MATERIAL

Basic Housing Profile : Aluminium
 Track Insulation : Polycarbonate

SIZE AND WEIGHT

Overall Dimension : 150mm x 40mm x 1000mm
 (Width x Depth x Length)
 Weight : Estimated 3.6 kg
 Warranty : 3 years subject to Eubiq Limited Statement (Applicable to track only)

OPTIONAL ACCESSORIES

SH1 Housing

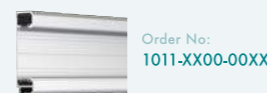

SH1 End Cap

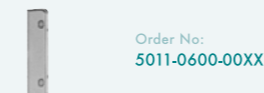

SH1 Cable Retainer



DMS1 Housing



DMS1 End Cap

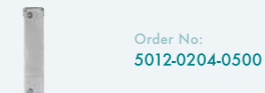

SFC3 Modular Track



SFC2b Blank Cover



Housing Joint Pins



DS4 Data Socket Housing

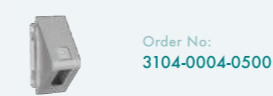

DS3b Blank

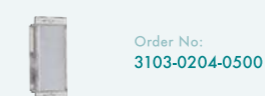

SH1 Internal Corner Cap SH1 Corner Links



SH1 External Corner Cap SH1 Corner Links

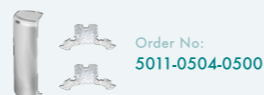

DMS1 Internal Corner Cap DMS1 Corner Links



DMS1 External Corner Cap DMS1 Corner Links



KH Kitchen Hook

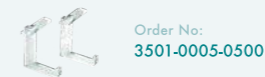

KR Kitchen Rail (L = 400mm)

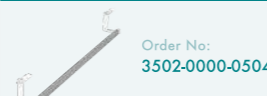

ADAPTORS PREMIUM SERIES



BS3
Premium British



GS3
Premium German



FR3
Premium France



ITA3
Premium Italian



ITL3
Premium
International Traveller



USB3
Premium
USB Charger
(Dual Port)



SP3
Premium
Surge Protector

STANDARD SERIES



BS4
Premium British



GS4
Premium German



FR4
Premium France



ITA4
Premium Italian



ITL4
Premium
International Traveller



CN4
Premium
International Traveller

ACCESSORIES



WS13
Wall Socket



PWT-TT
Premium Wall
Terminal (Titanium)



PWT-MR
Premium Wall
Terminal (Mirror
finishing)



DS3
Datacom Socket
Housing



DS4
Datacom Socket
Housing



TR50-TS
Toggle Switch
Lighthead



CL-04
COBRA
LED Task Light

MULTIMEDIA CONNECTORS



VGA 15-pin
Connector
(DE15F)



USB Type A
Connector
w/1.8m cable



HDMI
Connector



Audio Video
(AV)
Connector

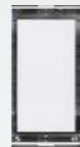

Mounting Frame
with Blank
Faceplate



Stereo Audio
3.5mm
Connector



Stereo Audio
6.3mm
Connector



F Coupler
Connector

